



NEC's NPN SILICON RF TWIN TRANSISTOR

UPA895TD

FEATURES

- **LOW VOLTAGE, LOW CURRENT OPERATION**
- **SMALL PACKAGE OUTLINE:**
1.2 mm x 0.8 mm
- **LOW HEIGHT PROFILE:**
Just 0.50 mm high
- **TWO LOW NOISE OSCILLATOR TRANSISTORS:**
NE851
- **IDEAL FOR 1-3 GHz OSCILLATORS**

DESCRIPTION

NEC's UPA895TD contains two NE851 high frequency silicon bipolar chips. The NE851 is an excellent oscillator chip, featuring low 1/f noise and high immunity to pushing effects. NEC's new ultra small TD package is ideal for all portable wireless applications where reducing board space is a prime consideration. Each transistor chip is independently mounted and easily configured for oscillator/buffer amplifier and other applications.

OUTLINE DIMENSIONS (Units in mm)

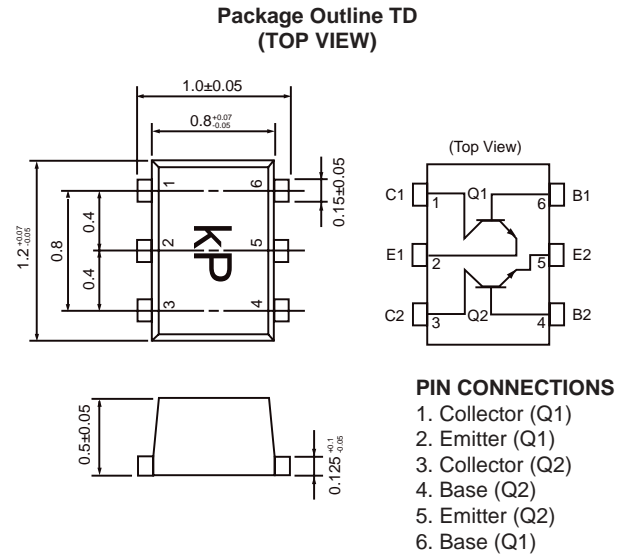

ORDERING INFORMATION

PART NUMBER	QUANTITY	PACKAGING
UPA895TD-T3	10K Pcs./Reel	Tape & Reel

ELECTRICAL CHARACTERISTICS (TA = 25°C)

PART NUMBER PACKAGE OUTLINE				UPA895TD TD		
	SYMBOLS	PARAMETERS AND CONDITIONS	UNITS	MIN	TYP	MAX
Q1 And Q2	ICBO	Collector Cutoff Current at VCB = 10 V, IE = 0	nA			600
	IEBO	Emitter Cutoff Current at VEB = 1 V, IC = 0	nA			600
	hFE	DC Current Gain ¹ at VCE = 3 V, IC = 7 mA		100	120	145
	fr	Gain Bandwidth at VCE = 1 V, IC = 15 mA, f = 2 GHz	GHz	5.0	6.5	
	Cre	Feedback Capacitance ² at VCB = 3 V, IE = 0, f = 1 MHz	pF		0.6	0.8
	S21E ²	Insertion Power Gain at VCE = 1 V, IC = 5 mA, f = 2 GHz	dB	3.0	4.0	
	S21E ²	Insertion Power Gain at VCE = 1 V, IC = 15 mA, f = 2 GHz	dB	4.5	5.5	
	NF	Noise Figure at VCE = 1 V, IC = 10 mA, f = 2 GHz	dB		1.9	2.5

- Notes: 1. Pulsed measurement, pulse width $\leq 350 \mu\text{s}$, duty cycle $\leq 2\%$.
 2. Collector to base capacitance when measured with capacitance meter (automatic balanced bridge method), with emitter connected to guard pin of capacitances meter.

ABSOLUTE MAXIMUM RATINGS¹ (T_A = 25°C)

SYMBOLS	PARAMETERS	UNITS	RATINGS	
			Q1	Q2
V _{CB0}	Collector to Base Voltage	V	9	9
V _{CEO}	Collector to Emitter Voltage	V	5.5	5.5
V _{EBO}	Emitter to Base Voltage	V	1.5	1.5
I _C	Collector Current	mA	100	100
P _T	Total Power Dissipation ²	mW	190 for 1 element 210 for 2 elements	
T _J	Junction Temperature	°C	150	150
T _{STG}	Storage Temperature	°C	-65 to +150	

Note: 1. Operation in excess of any one of these parameters may result in permanent damage.
 2. Mounted on 1.08cm² x 1.0 mm(t) glass epoxy substrate.

NOISE FIGURE, ASSOCIATED GAIN vs. COLLECTOR CURRENT

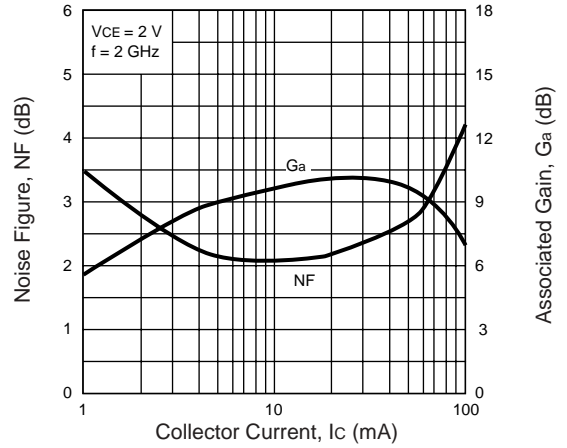

TYPICAL PERFORMANCE CURVES (T_A = 25°C)

TOTAL POWER DISSIPATION vs. AMBIENT TEMPERATURE

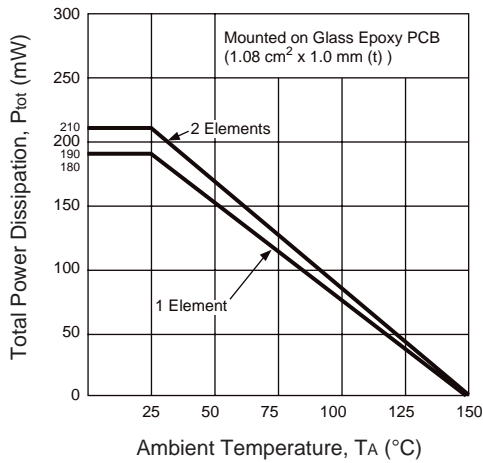

REVERSE TRANSFER CAPACITANCE vs. COLLECTOR TO BASE VOLTAGE

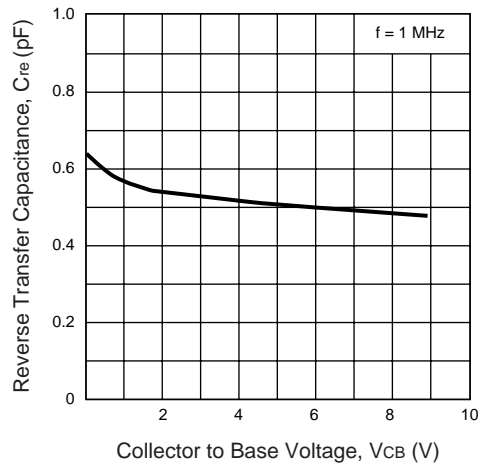

COLLECTOR CURRENT vs. BASE TO EMITTER VOLTAGE

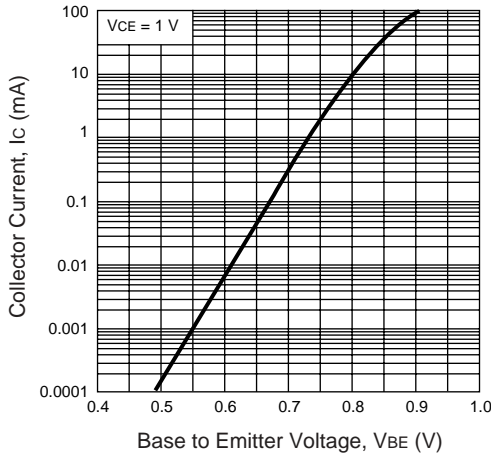

COLLECTOR CURRENT vs. BASE TO EMITTER VOLTAGE

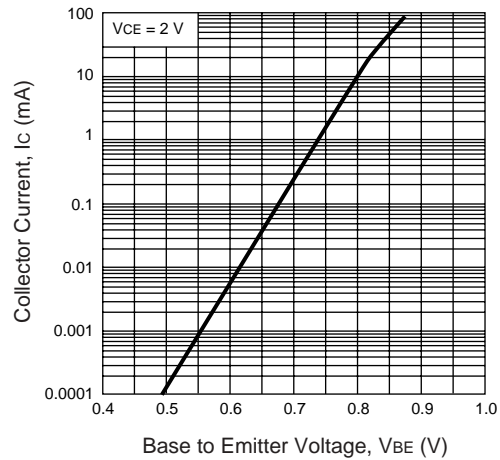

TYPICAL PERFORMANCE CURVES (TA = 25°C)

COLLECTOR CURRENT vs. COLLECTOR TO EMITTER VOLTAGE

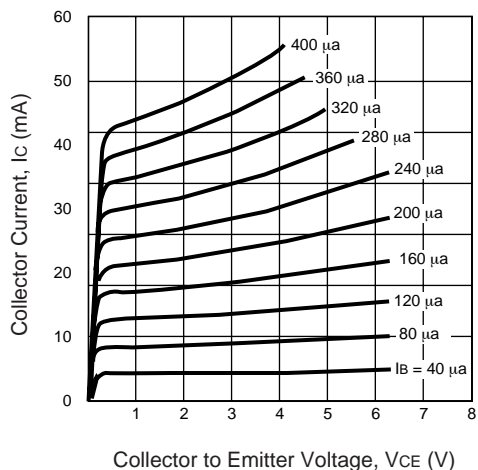

GAIN BANDWIDTH PRODUCT vs. COLLECTOR CURRENT

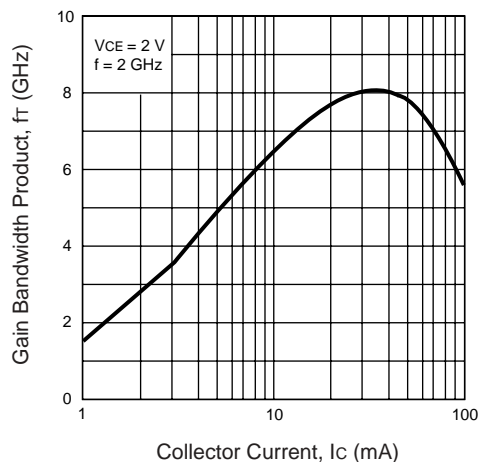

DC CURRENT GAIN vs. COLLECTOR CURRENT

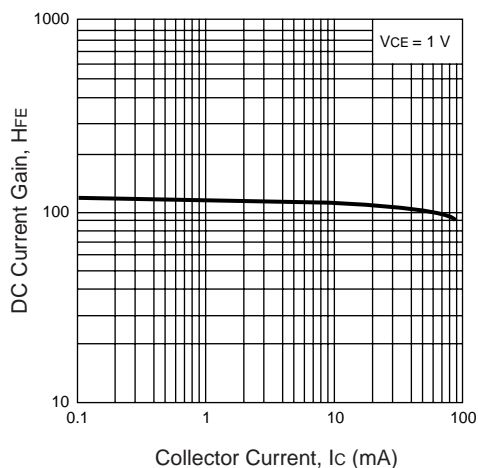

DC CURRENT GAIN vs. COLLECTOR CURRENT

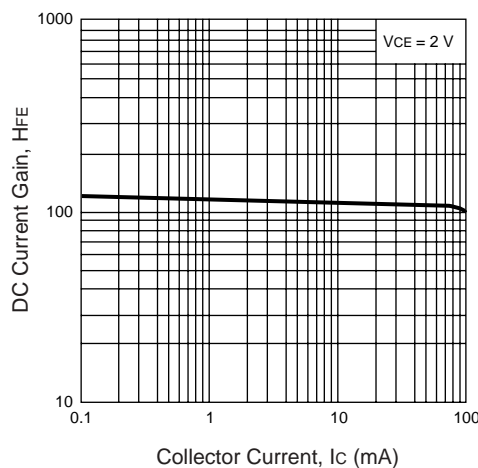

INSERTION POWER GAIN, MAG, MSG vs. FREQUENCY

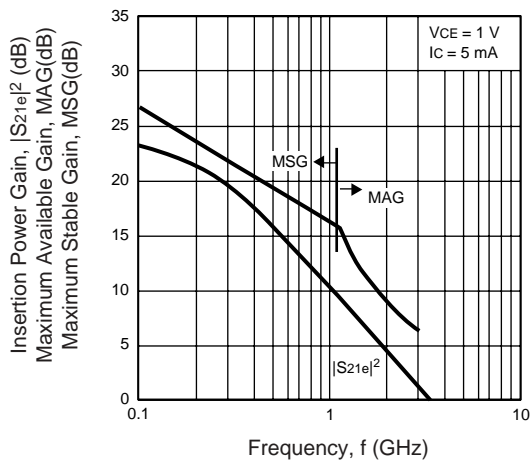

INSERTION POWER GAIN, MAG, MSG vs. FREQUENCY

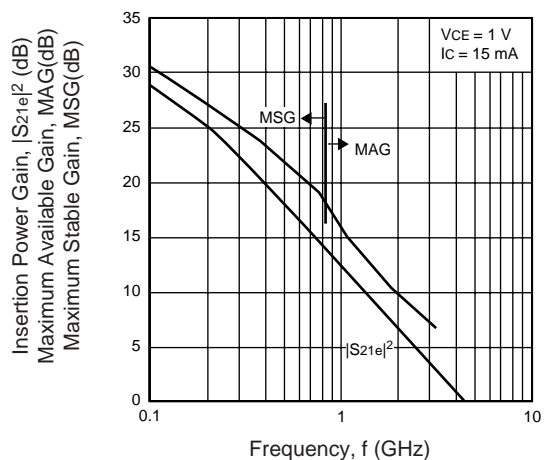

TYPICAL PERFORMANCE CURVES (T_A = 25°C)

INSERTION POWER GAIN, MAG, MSG vs. FREQUENCY

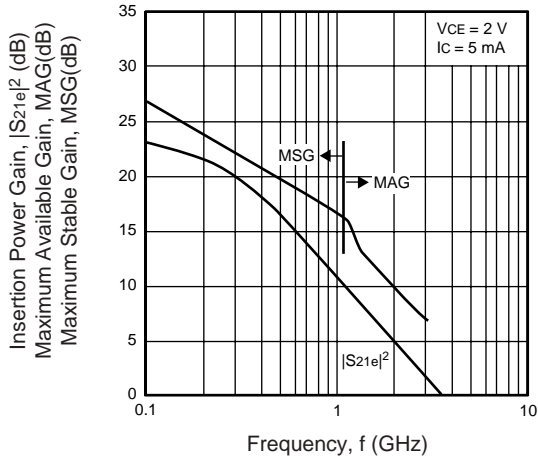

INSERTION POWER GAIN, MAG, MSG vs. COLLECTOR CURRENT

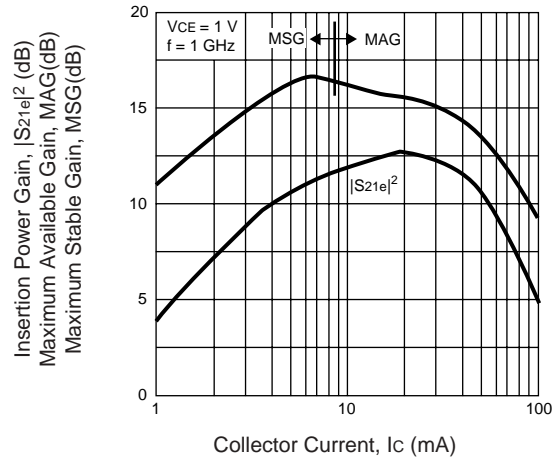

INSERTION POWER GAIN, MAG, MSG vs. COLLECTOR CURRENT

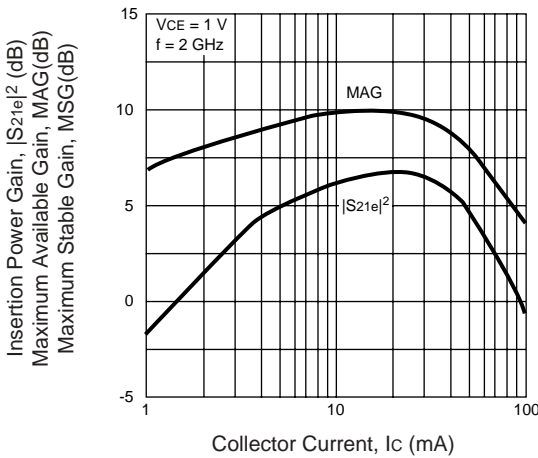

INSERTION POWER GAIN, MAG, MSG vs. COLLECTOR CURRENT

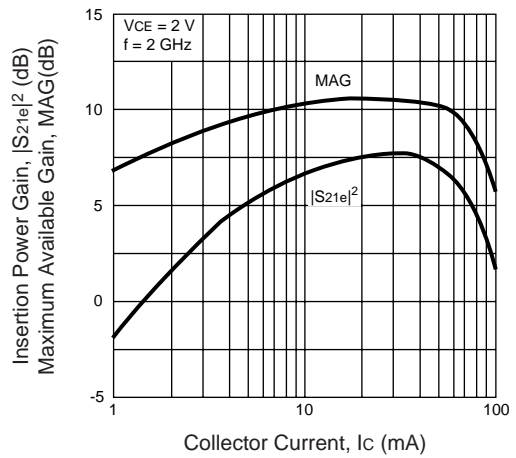

NOISE FIGURE, ASSOCIATED GAIN vs. COLLECTOR CURRENT

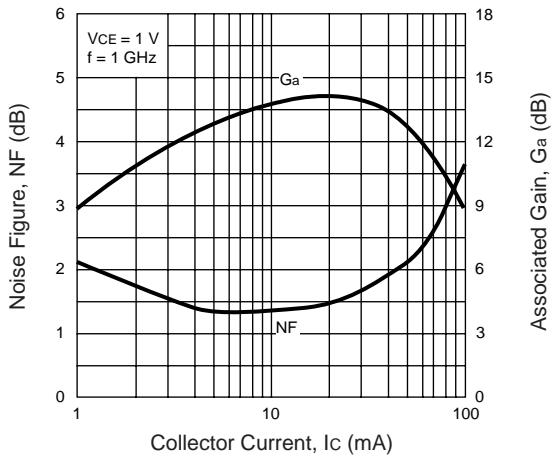

NOISE FIGURE, ASSOCIATED GAIN vs. COLLECTOR CURRENT

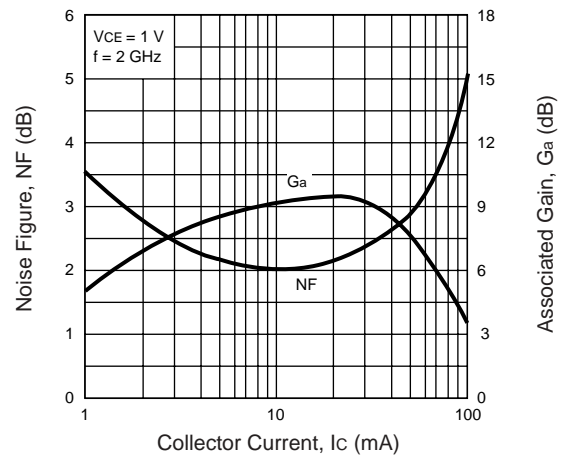

TYPICAL SCATTERING PARAMETERS

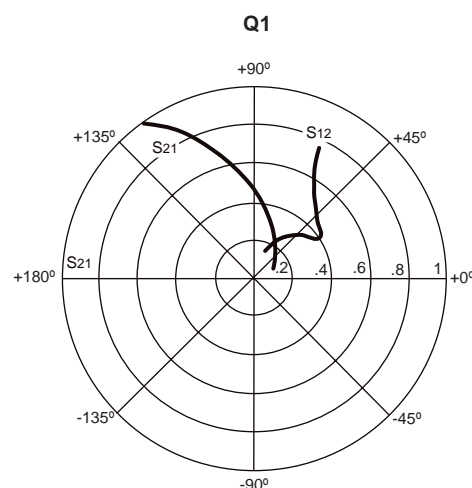
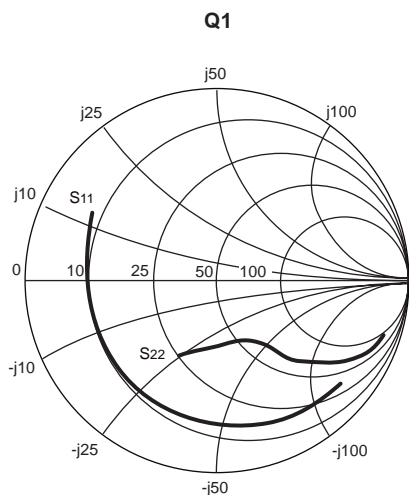

UPA895TD Q1

VCE = 1 V, IC = 5 mA

Frequency GHz	S11		S21		S12		S22		K	MAG ¹ (dB)
	MAG	ANG	MAG	ANG	MAG	ANG	MAG	ANG		
0.100	0.834	-40.0	13.251	154.1	0.032	68.0	0.911	-19.3	0.124	26.11
0.200	0.782	-74.1	11.289	135.3	0.054	53.1	0.769	-33.0	0.174	23.24
0.300	0.729	-98.7	9.275	121.5	0.065	43.8	0.643	-40.9	0.262	21.56
0.400	0.701	-116.6	7.696	111.6	0.071	38.0	0.552	-45.7	0.338	20.34
0.500	0.682	-129.7	6.501	104.1	0.075	34.8	0.488	-48.7	0.417	19.39
0.600	0.674	-139.9	5.593	98.1	0.077	33.1	0.444	-51.0	0.488	18.61
0.700	0.667	-148.0	4.892	93.1	0.079	32.3	0.411	-53.0	0.563	17.93
0.800	0.667	-154.6	4.344	88.7	0.080	32.3	0.388	-55.0	0.628	17.35
0.900	0.666	-160.1	3.899	84.8	0.081	32.8	0.371	-57.1	0.697	16.83
1.000	0.669	-165.0	3.542	81.2	0.082	33.7	0.358	-59.4	0.751	16.36
1.100	0.670	-169.2	3.237	77.8	0.083	34.8	0.348	-61.9	0.817	15.93
1.200	0.671	-172.9	2.981	74.7	0.084	36.3	0.341	-64.3	0.873	15.51
1.300	0.673	-176.3	2.760	71.7	0.085	37.8	0.335	-67.1	0.930	15.12
1.400	0.675	-179.3	2.569	68.8	0.086	39.6	0.332	-69.9	0.981	14.74
1.500	0.677	-177.8	2.400	66.1	0.088	41.6	0.330	-72.8	1.028	13.35
1.600	0.679	175.2	2.252	63.5	0.090	43.5	0.330	-76.0	1.069	12.40
1.700	0.683	172.7	2.120	61.0	0.092	45.6	0.332	-79.1	1.100	11.72
1.800	0.686	170.4	2.003	58.6	0.094	47.6	0.335	-82.3	1.122	11.15
1.900	0.691	168.3	1.899	56.3	0.097	49.6	0.339	-85.6	1.130	10.72
2.000	0.695	166.4	1.802	54.1	0.100	51.5	0.345	-88.9	1.140	10.28
2.100	0.702	164.5	1.717	51.9	0.104	53.3	0.351	-92.1	1.131	9.99
2.200	0.706	162.8	1.635	49.7	0.108	55.0	0.358	-95.2	1.127	9.64
2.300	0.711	161.3	1.565	47.8	0.112	56.5	0.366	-98.4	1.113	9.41
2.400	0.716	159.8	1.496	45.8	0.117	57.9	0.374	-101.2	1.102	9.14
2.500	0.720	158.4	1.433	43.9	0.121	59.2	0.382	-104.0	1.088	8.92
2.600	0.723	157.2	1.373	42.1	0.126	60.3	0.391	-106.6	1.076	8.68
2.700	0.726	156.1	1.320	40.4	0.132	61.4	0.401	-109.2	1.059	8.52
2.800	0.730	154.9	1.269	38.7	0.138	62.4	0.411	-111.5	1.040	8.44
2.900	0.732	153.9	1.224	37.3	0.144	63.2	0.420	-113.9	1.023	8.37
2.950	0.734	153.5	1.202	36.5	0.147	63.6	0.425	-115.1	1.011	8.49
3.000	0.735	152.9	1.180	35.8	0.150	63.9	0.431	-116.1	1.002	8.68

Note:

1. Gain Calculations:

$$MAG = \frac{|S_{21}|}{|S_{12}|} (K \pm \sqrt{K^2 - 1}). \text{ When } K \leq 1, \text{ MAG is undefined and MSG values are used. } MSG = \frac{|S_{21}|}{|S_{12}|}, K = \frac{1 + |\Delta|^2 - |S_{11}|^2 - |S_{22}|^2}{2 |S_{12} S_{21}|}, \Delta = S_{11} S_{22} - S_{21} S_{12}$$

MAG = Maximum Available Gain

MSG = Maximum Stable Gain

TYPICAL SCATTERING PARAMETERS

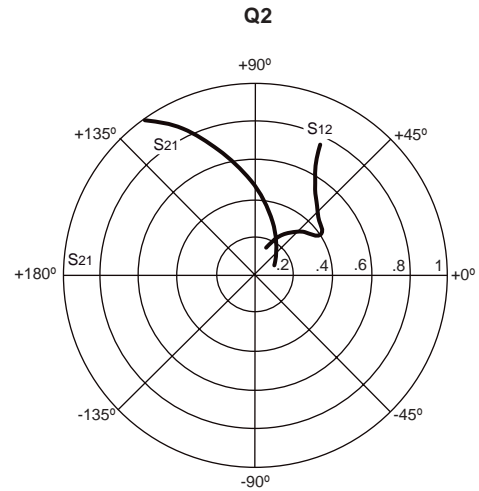
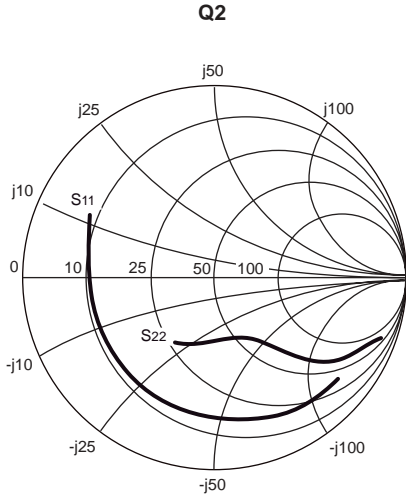

UPA895TD Q2

V_{CE} = 1 V, I_c = 5 mA

Frequency GHz	S ₁₁		S ₂₁		S ₁₂		S ₂₂		K	MAG ¹ (dB)
	MAG	ANG	MAG	ANG	MAG	ANG	MAG	ANG		
0.100	0.833	-39.7	13.156	153.7	0.032	69.1	0.910	-19.4	0.116	26.12
0.200	0.774	-73.7	11.160	134.8	0.053	53.3	0.767	-33.0	0.188	23.20
0.300	0.716	-98.2	9.150	120.9	0.065	44.0	0.642	-40.9	0.281	21.51
0.400	0.685	-116.2	7.576	110.9	0.071	38.6	0.553	-45.6	0.361	20.29
0.500	0.666	-129.4	6.400	103.4	0.075	35.6	0.491	-48.6	0.443	19.33
0.600	0.657	-139.6	5.506	97.4	0.077	34.0	0.448	-50.8	0.516	18.54
0.700	0.650	-147.8	4.815	92.3	0.079	33.5	0.417	-52.7	0.593	17.86
0.800	0.650	-154.4	4.275	87.8	0.080	33.6	0.395	-54.5	0.660	17.27
0.900	0.649	-160.0	3.836	83.9	0.081	34.3	0.378	-56.3	0.732	16.74
1.000	0.651	-164.9	3.482	80.2	0.082	35.4	0.366	-58.4	0.791	16.26
1.100	0.652	-169.2	3.181	76.8	0.083	36.7	0.355	-60.5	0.858	15.81
1.200	0.654	-172.9	2.929	73.6	0.085	38.4	0.347	-62.7	0.916	15.38
1.300	0.655	-176.3	2.713	70.6	0.086	40.1	0.340	-65.1	0.973	14.97
1.400	0.658	-179.3	2.526	67.8	0.088	42.0	0.335	-67.8	1.021	13.68
1.500	0.661	177.9	2.363	65.1	0.090	44.1	0.332	-70.4	1.062	12.66
1.600	0.664	175.4	2.220	62.5	0.093	46.0	0.330	-73.3	1.094	11.92
1.700	0.669	173.0	2.093	60.0	0.096	48.1	0.329	-76.3	1.117	11.33
1.800	0.673	170.8	1.981	57.5	0.099	50.1	0.330	-79.5	1.131	10.82
1.900	0.679	168.7	1.881	55.2	0.102	52.1	0.331	-82.7	1.135	10.41
2.000	0.683	166.9	1.788	52.9	0.106	53.8	0.333	-86.1	1.139	9.99
2.100	0.689	165.2	1.706	50.8	0.111	55.5	0.335	-89.6	1.131	9.67
2.200	0.694	163.6	1.630	48.6	0.116	57.1	0.339	-92.9	1.121	9.37
2.300	0.698	162.1	1.561	46.5	0.121	58.5	0.341	-96.6	1.112	9.08
2.400	0.703	160.7	1.497	44.5	0.126	59.7	0.345	-100.0	1.097	8.84
2.500	0.706	159.4	1.437	42.6	0.132	60.7	0.350	-103.6	1.085	8.59
2.600	0.711	158.2	1.381	40.7	0.138	61.6	0.356	-106.9	1.066	8.42
2.700	0.714	157.1	1.331	38.9	0.145	62.5	0.363	-110.4	1.048	8.28
2.800	0.719	156.0	1.284	37.1	0.152	63.1	0.371	-113.6	1.024	8.32
2.900	0.722	154.9	1.240	35.5	0.159	63.7	0.379	-116.9	1.008	8.39
3.000	0.726	154.0	1.199	33.9	0.167	63.9	0.388	-120.0	0.983	8.57

Note:

1. Gain Calculations:

$$MAG = \frac{|S_{21}|}{|S_{12}|} (K \pm \sqrt{K^2 - 1}). \text{ When } K \leq 1, \text{ MAG is undefined and MSG values are used. } MSG = \frac{|S_{21}|}{|S_{12}|}, K = \frac{1 + |\Delta|^2 - |S_{11}|^2 - |S_{22}|^2}{2 |S_{12} S_{21}|}, \Delta = S_{11} S_{22} - S_{21} S_{12}$$

MAG = Maximum Available Gain

MSG = Maximum Stable Gain

TYPICAL SCATTERING PARAMETERS

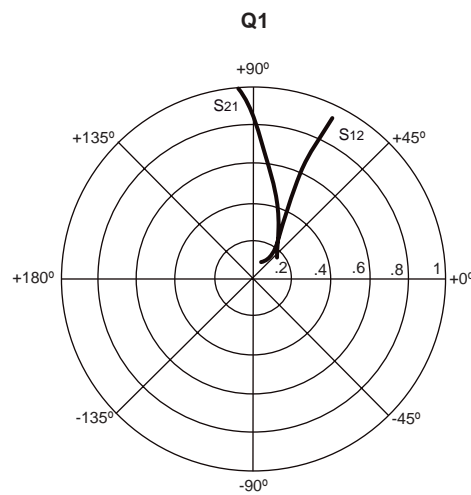
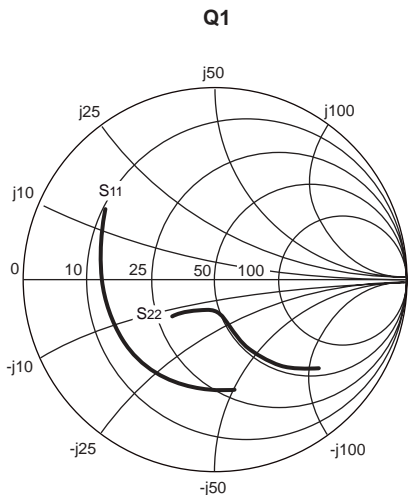

UPA895TD Q1

V_{CE} = 2 V, I_c = 20 mA

Frequency GHz	S ₁₁		S ₂₁		S ₁₂		S ₂₂		K	MAG ¹ (dB)
	MAG	ANG	MAG	ANG	MAG	ANG	MAG	ANG		
0.100	0.586	-81.0	32.902	136.3	0.021	59.8	0.714	-40.2	0.272	31.89
0.200	0.577	-121.5	21.870	115.8	0.030	50.0	0.478	-58.2	0.454	28.68
0.300	0.567	-141.5	15.722	105.3	0.035	50.0	0.351	-65.9	0.618	26.56
0.400	0.570	-152.9	12.157	98.6	0.039	51.5	0.280	-70.4	0.735	24.91
0.500	0.571	-160.7	9.881	93.8	0.044	53.8	0.236	-73.6	0.826	23.53
0.600	0.575	-166.6	8.313	89.9	0.049	56.1	0.209	-76.3	0.889	22.33
0.700	0.578	-171.4	7.165	86.6	0.054	58.0	0.189	-79.1	0.938	21.26
0.800	0.583	-175.2	6.300	83.7	0.059	59.7	0.177	-81.9	0.971	20.30
0.900	0.586	-178.5	5.616	81.0	0.064	61.0	0.168	-85.1	0.998	19.43
1.000	0.593	178.5	5.075	78.4	0.069	62.2	0.163	-88.4	1.010	18.02
1.100	0.595	175.8	4.619	76.0	0.075	63.0	0.160	-92.1	1.028	16.87
1.200	0.599	173.5	4.242	73.7	0.080	63.8	0.158	-95.6	1.038	16.02
1.300	0.602	171.2	3.919	71.5	0.086	64.3	0.158	-99.4	1.049	15.23
1.400	0.606	169.2	3.640	69.4	0.092	64.7	0.160	-103.0	1.055	14.56
1.500	0.609	167.2	3.398	67.4	0.097	65.1	0.162	-106.5	1.062	13.92
1.600	0.612	165.3	3.186	65.4	0.103	65.3	0.166	-109.9	1.067	13.34
1.700	0.616	163.5	2.998	63.5	0.108	65.5	0.171	-113.1	1.067	12.83
1.800	0.621	161.8	2.831	61.6	0.114	65.6	0.178	-116.1	1.067	12.37
1.900	0.627	160.2	2.685	59.8	0.120	65.6	0.185	-118.9	1.059	12.01
2.000	0.631	158.8	2.551	58.0	0.126	65.6	0.192	-121.5	1.057	11.62
2.100	0.637	157.3	2.433	56.3	0.131	65.5	0.201	-124.0	1.047	11.34
2.200	0.642	156.1	2.321	54.5	0.137	65.4	0.209	-126.2	1.042	11.03
2.300	0.647	154.9	2.222	52.9	0.143	65.2	0.218	-128.4	1.034	10.79
2.400	0.651	153.8	2.129	51.2	0.149	65.0	0.227	-130.2	1.028	10.52
2.500	0.654	152.8	2.044	49.7	0.155	64.9	0.236	-131.9	1.023	10.29
2.600	0.657	151.8	1.963	48.1	0.160	64.6	0.244	-133.3	1.018	10.06
2.700	0.660	151.0	1.892	46.7	0.166	64.5	0.253	-134.8	1.012	9.89
2.800	0.663	150.1	1.825	45.2	0.172	64.2	0.261	-135.8	1.005	9.84
2.900	0.664	149.4	1.764	43.9	0.178	64.0	0.270	-137.1	0.999	9.96
3.000	0.667	148.7	1.707	42.5	0.184	63.7	0.278	-138.0	0.991	9.68

Note:

1. Gain Calculations:

$$MAG = \frac{|S_{21}|}{|S_{12}|} (K \pm \sqrt{K^2 - 1}). \text{ When } K \leq 1, \text{ MAG is undefined and MSG values are used. } MSG = \frac{|S_{21}|}{|S_{12}|}, K = \frac{1 + |\Delta|^2 - |S_{11}|^2 - |S_{22}|^2}{2 |S_{12} S_{21}|}, \Delta = S_{11} S_{22} - S_{21} S_{12}$$

MAG = Maximum Available Gain

MSG = Maximum Stable Gain

TYPICAL SCATTERING PARAMETERS

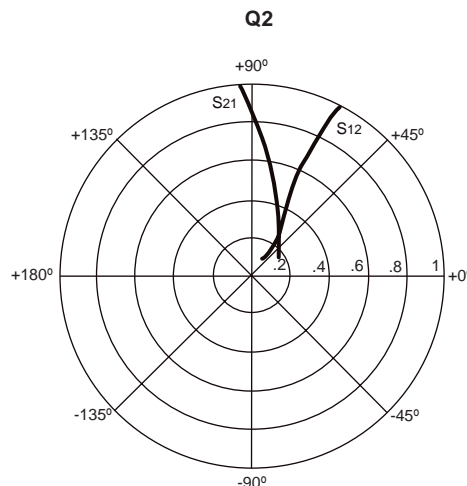
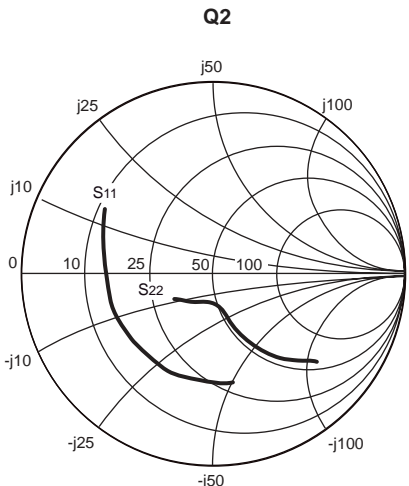

UPA895TD Q2

V_{CE} = 2 V, I_c = 20 mA

Frequency GHz	S ₁₁		S ₂₁		S ₁₂		S ₂₂		K	MAG ¹ (dB)
	MAG	ANG	MAG	ANG	MAG	ANG	MAG	ANG		
0.100	0.575	-80.7	32.678	135.7	0.021	58.6	0.711	-40.1	0.296	31.88
0.200	0.555	-121.1	21.589	115.2	0.030	51.5	0.474	-57.3	0.485	28.63
0.300	0.543	-141.3	15.485	104.6	0.035	51.3	0.349	-64.3	0.653	26.46
0.400	0.544	-152.8	11.960	98.0	0.040	53.3	0.280	-68.2	0.767	24.74
0.500	0.545	-160.7	9.721	93.1	0.045	55.7	0.238	-70.8	0.854	23.34
0.600	0.549	-166.7	8.180	89.2	0.050	57.8	0.211	-72.8	0.911	22.10
0.700	0.552	-171.5	7.050	85.8	0.056	59.6	0.193	-75.0	0.955	21.00
0.800	0.557	-175.3	6.195	82.8	0.062	61.1	0.181	-77.1	0.985	20.03
0.900	0.560	-178.6	5.523	80.1	0.067	62.3	0.171	-79.5	1.009	18.56
1.000	0.566	178.5	4.989	77.5	0.073	63.2	0.165	-82.2	1.021	17.44
1.100	0.569	175.8	4.540	75.0	0.079	64.0	0.159	-85.3	1.036	16.42
1.200	0.572	173.5	4.170	72.7	0.085	64.6	0.156	-88.3	1.046	15.58
1.300	0.576	171.3	3.854	70.4	0.091	65.0	0.153	-91.7	1.055	14.82
1.400	0.580	169.3	3.583	68.3	0.097	65.3	0.152	-95.2	1.060	14.17
1.500	0.584	167.4	3.347	66.2	0.103	65.4	0.151	-98.7	1.064	13.56
1.600	0.588	165.6	3.141	64.2	0.110	65.7	0.152	-102.3	1.066	13.01
1.700	0.592	164.0	2.960	62.2	0.116	65.7	0.153	-105.9	1.064	12.53
1.800	0.598	162.5	2.799	60.3	0.122	65.6	0.156	-109.4	1.061	12.09
1.900	0.604	161.0	2.657	58.4	0.129	65.5	0.159	-113.0	1.054	11.73
2.000	0.608	159.7	2.527	56.5	0.135	65.4	0.163	-116.5	1.052	11.34
2.100	0.615	158.4	2.412	54.8	0.141	65.2	0.168	-120.1	1.043	11.05
2.200	0.619	157.4	2.307	53.0	0.148	65.0	0.173	-123.5	1.037	10.75
2.300	0.624	156.3	2.210	51.2	0.154	64.7	0.178	-127.2	1.032	10.48
2.400	0.629	155.3	2.121	49.6	0.161	64.4	0.184	-130.2	1.025	10.23
2.500	0.633	154.3	2.039	47.9	0.167	64.1	0.190	-133.3	1.021	9.99
2.600	0.637	153.4	1.963	46.3	0.173	63.7	0.197	-136.0	1.014	9.81
2.700	0.640	152.7	1.894	44.7	0.180	63.4	0.204	-138.7	1.009	9.64
2.800	0.644	151.9	1.831	43.1	0.187	63.1	0.212	-140.8	1.000	9.87
2.900	0.647	151.1	1.772	41.7	0.194	62.6	0.220	-143.2	0.993	9.62
3.000	0.651	150.4	1.718	40.2	0.200	62.2	0.229	-145.1	0.984	9.33

Note:

1. Gain Calculations:

$$MAG = \frac{|S_{21}|}{|S_{12}|} (K \pm \sqrt{K^2 - 1}). \text{ When } K \leq 1, \text{ MAG is undefined and MSG values are used. } MSG = \frac{|S_{21}|}{|S_{12}|}, K = \frac{1 + |\Delta|^2 - |S_{11}|^2 - |S_{22}|^2}{2 |S_{12} S_{21}|}, \Delta = S_{11} S_{22} - S_{21} S_{12}$$

MAG = Maximum Available Gain

MSG = Maximum Stable Gain

UPA895TD NONLINEAR MODEL

BJT NONLINEAR MODEL PARAMETERS(1)

Parameters	Q1	Q2	Parameters	Q1	Q2
IS	137e-18	137e-18	MJC	0.14	0.14
BF	166	166	XCJC	0.5	0.5
NF	0.9871	0.9871	CJS	0	0
VAF	20.4	20.4	VJS	0.75	0.75
IKF	50	50	MJS	0	0
ISE	80.4e-15	80.4e-15	FC	0.55	0.55
NE	2.4	2.4	TF	18e-12	18e-12
BR	28.7	28.7	XTF	0.1	0.1
NR	0.9889	0.9889	VTF	2	2
VAR	2.7	2.7	ITF	0.03	0.03
IKR	0.021	0.021	PTF	0	0
ISC	532e-18	532e-18	TR	1.0e-9	1.0e-9
NC	1.28	1.28	EG	1.11	1.11
RE	0.45	0.45	XTB	0	0
RB	4	4	XTI	3	3
RBM	1	1	KF*	0	0
IRB	0	0	AF*	1	1.00
RC	1.7	1.7			
CJE	2.4e-12	2.4e-12			
VJE	0.87	0.87			
MJE	0.34	0.34			
CJC	0.65e-12	0.65e-12			
VJC	0.52	0.52			

(1) Gummel-Poon Model

* Set to default value.

AF and KF are 1/f noise parameters and are bias dependent. The appropriate values for the 1/f noise parameters (AF and KF) shall be chosen from the table below, according to the desired current range.

	Ic = 5 mA	Ic = 10 mA	Ic = 15 mA
KF	4.547e-15	855e-12	1.73e-9
AF	1.4	2.551	2.626

For a better understanding on AF and KF parameters, please refer to AN1026.

MODEL RANGE

Frequency: 0.1 to 3.0 GHz
 Bias: VCE = 0.5 V to 3 V, Ic = 1 mA to 20 mA
 Date: 4/03

SCHEMATIC

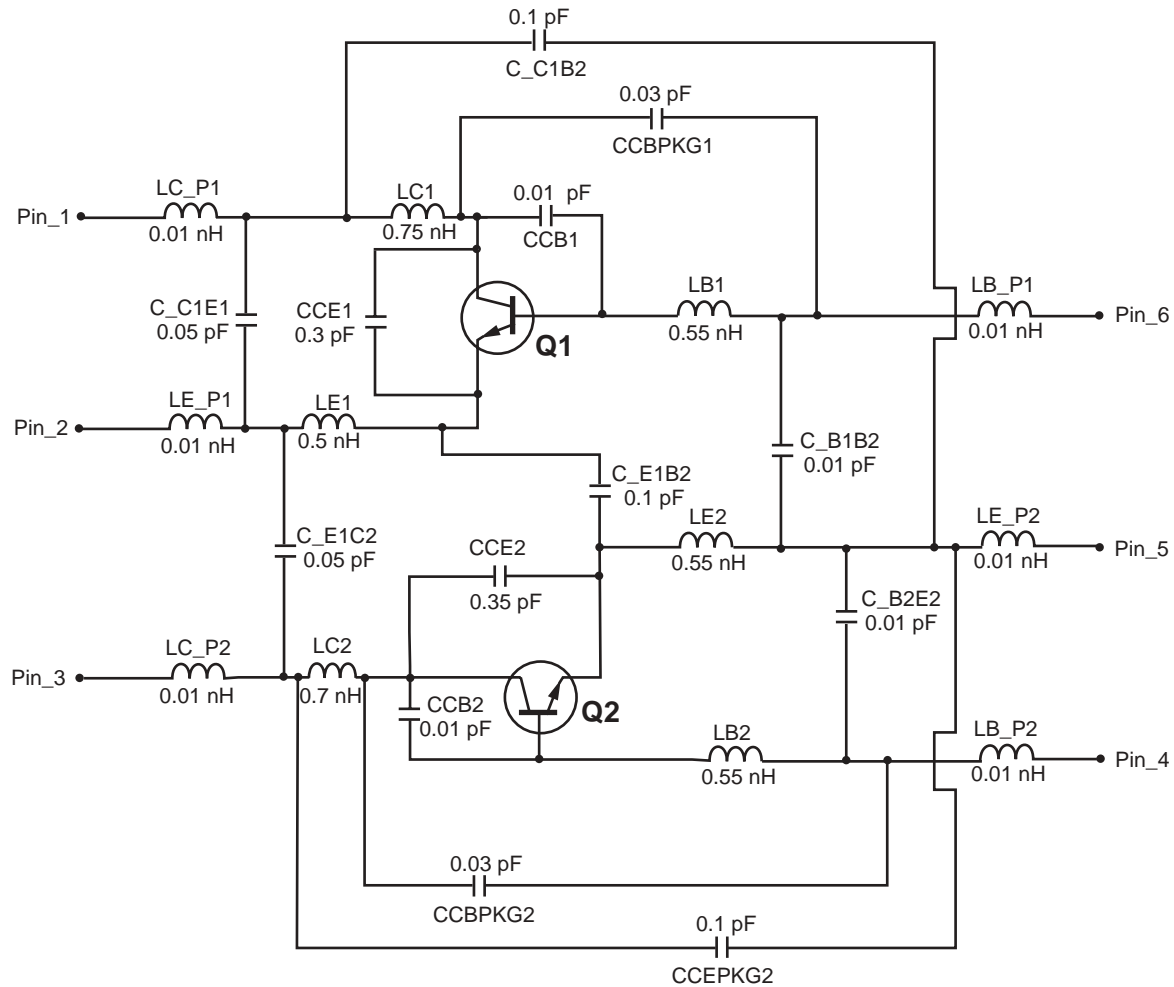

MODEL RANGE

Frequency: 0.1 to 3.0 GHz

Bias: $V_{CE} = 0.5\text{ V}$ to 3 V , $I_c = 1\text{ mA}$ to 20 mA

Date: 04/03

Life Support Applications

These NEC products are not intended for use in life support devices, appliances, or systems where the malfunction of these products can reasonably be expected to result in personal injury. The customers of CEL using or selling these products for use in such applications do so at their own risk and agree to fully indemnify CEL for all damages resulting from such improper use or sale.

CEL California Eastern Laboratories, Your source for NEC RF, Microwave, Optoelectronic, and Fiber Optic Semiconductor Devices.

4590 Patrick Henry Drive • Santa Clara, CA 95054-1817 • (408) 988-3500 • FAX (408) 988-0279 • www.cel.com

DATA SUBJECT TO CHANGE WITHOUT NOTICE

04/18/2003

NEC

A Business Partner of NEC Compound Semiconductor Devices, Ltd.